





Option
r1
s1

| Height in mm |  |  |  |  |  |
|--------------|---|---|---|---|---|
| - 1020 | 2 | 2 | 2 | 4 | 4 |
| 1021 - 1720 | 2 | 2 | 2 | 6 | 6 |
| 1721 - 2420 | 2 | 2 | 2 | 8 | 8 |
| 2421 - 3120 | 2 | 2 | 2 | 10 | 10 |
| 3121 - 4000 | 2 | 2 | 2 | 14 | 14 |

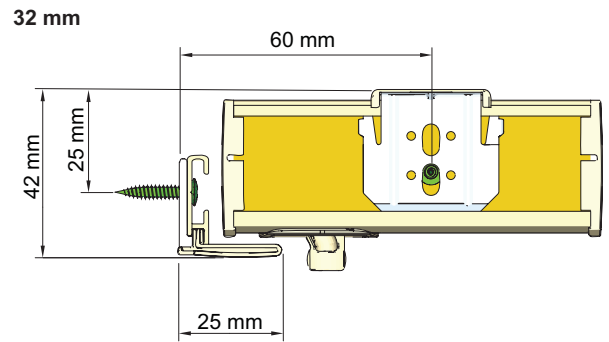
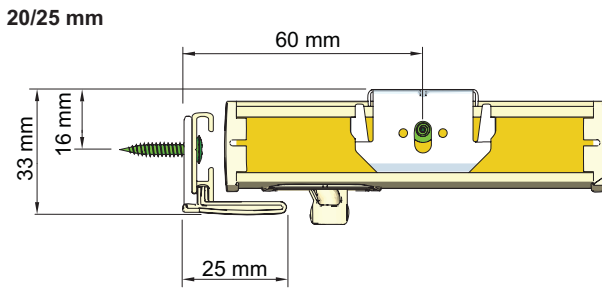

1

2

3

4

