

Aufmontage / Wandmontage [W1]

Beim Öffnen Produkt nicht mit scharfem Messer beschädigen!
 Schrauben-Montage: Schraubenzieher Größe 2 (POZIDRIVE) verwenden. Keinen Akkuschrauber nutzen. Schienen-Demontage: Schraubenzieher, flach, Größe 2 verwenden. Ausschließ-

lich die mitgelieferten Originalschrauben verwenden!

Modell
PR60/65
PR61/66

Montage- und Bedienungsanleitung PB - D

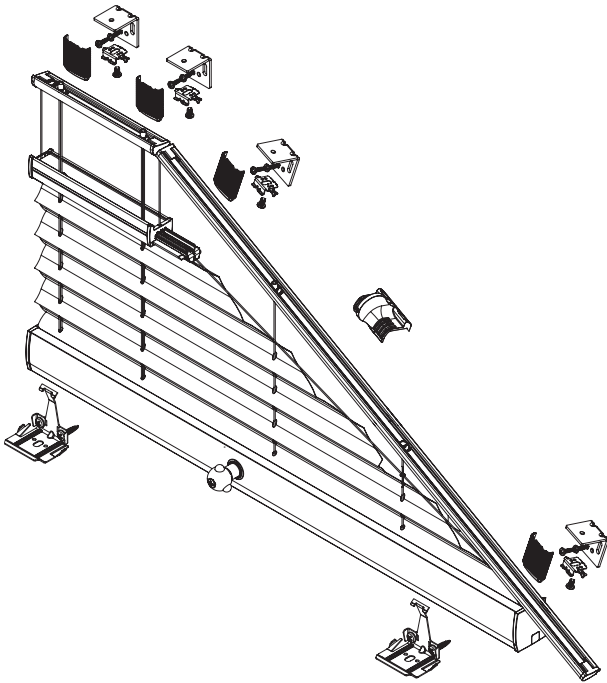

Anlagenbreite	Anzahl der Bauteile						
0 - 80 cm	2	var	var	var	1	var	var
81 - 115 cm	3	var	var	var	1	var	var
116 - 150 cm	4	var	var	var	1	var	var
151 - 220 cm	5	var	var	var	1	var	var
221 - 230 cm	6	var	var	var	1	var	var

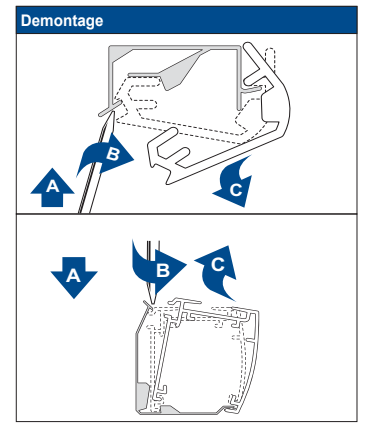
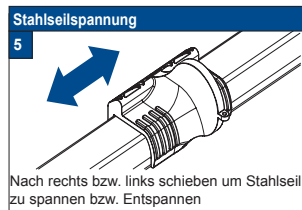
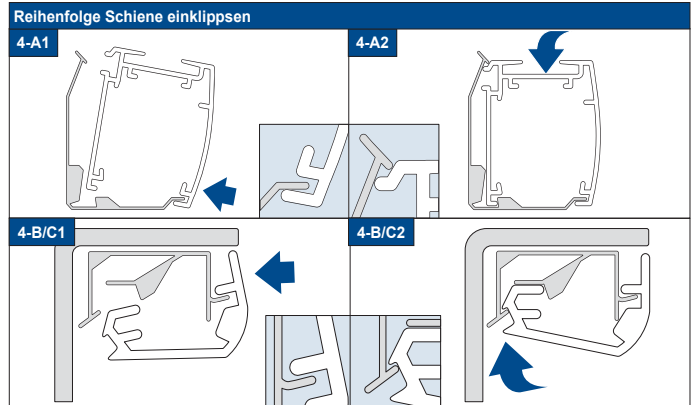
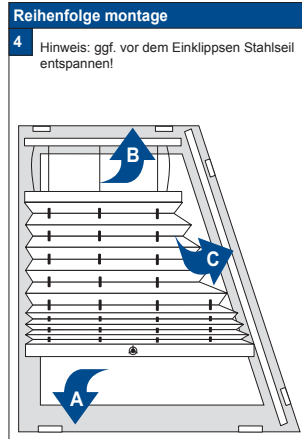
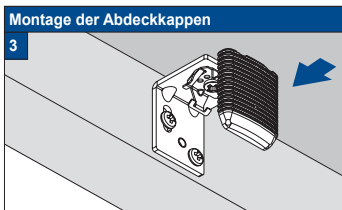
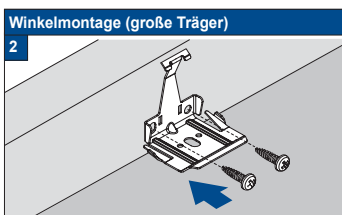
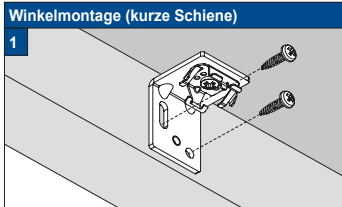
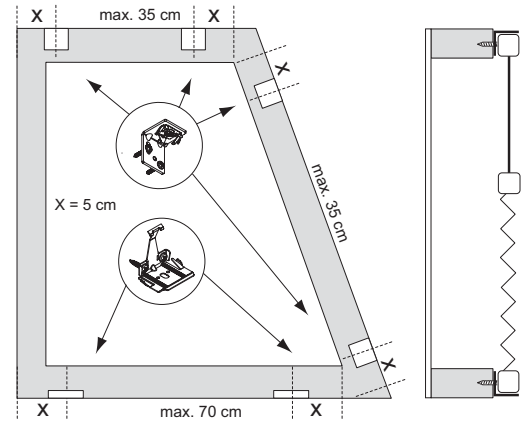

21-03-2014