

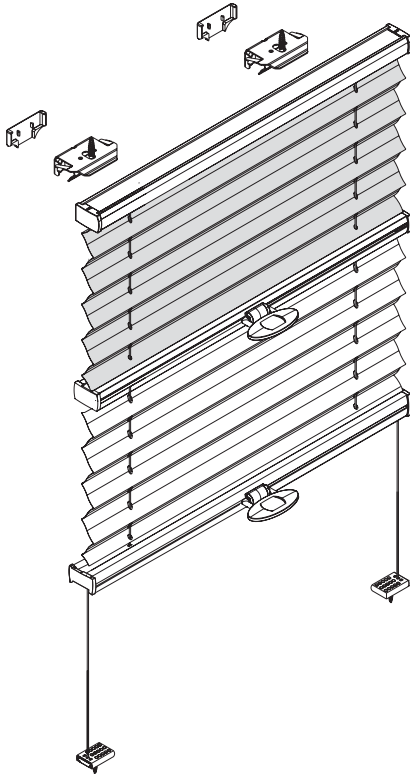







Deckenmontage / Glasleistenmontage [D1]

Beim Öffnen Produkt nicht mit scharfem Messer beschädigen! Schrauben-Montage: Schraubenzieher Größe 2 (POZIDRIVE) verwenden. Keinen Akkuschrauber nutzen. Schienen-Demontage: Schraubenzieher, flach, Größe 2 verwenden. Ausschließ-

Modell
BB30/31
BB35/36

Montage- und Bedienungsanleitung PB - D



Anlagenbreite	Anzahl der Bauteile			
0 - 80 cm	 2	 2	 2	 4
81 - 150 cm	 3	 3	 2	 5

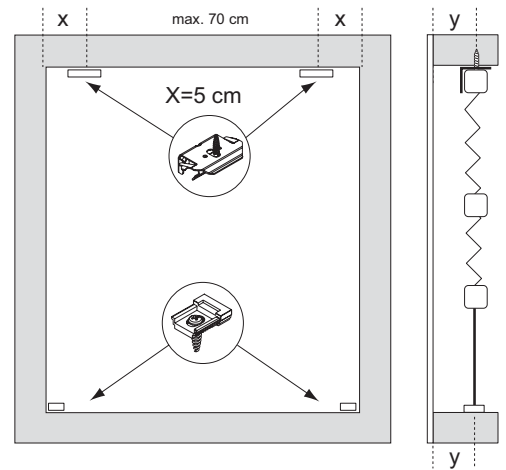

Montage der Abdeckkappen

1

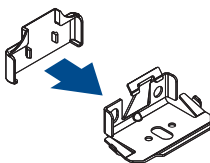

Trägermontage

2

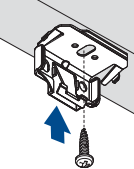

Reihenfolge montage

4

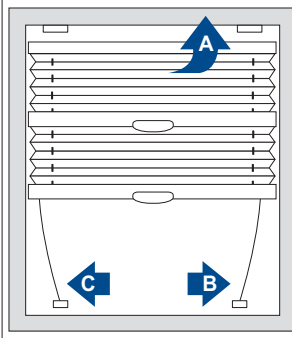

Reihenfolge Schiene einklipsen

4-A1

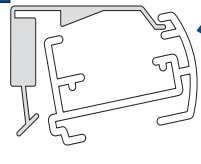

4-A2

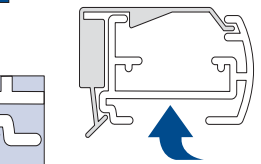

4-B/C 1

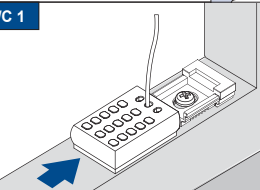

4-B/C 2

5mm variable bereich

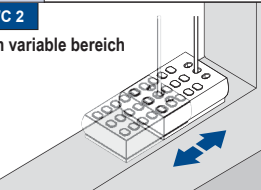

Bedienung

5

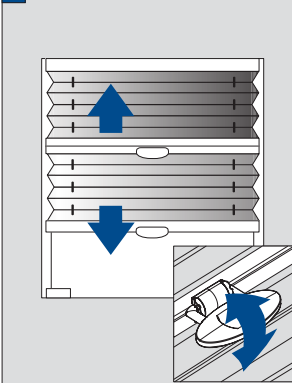

Spannfußmontage

3

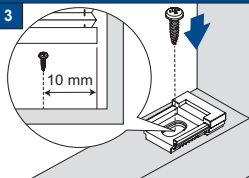

Demontage

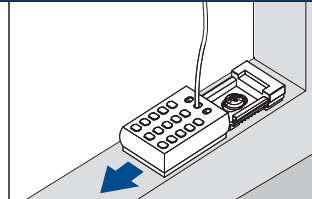
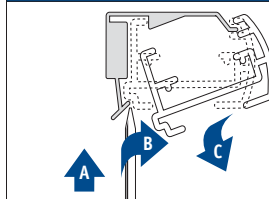

18-04-2014