





Aufmontage / Wandmontage [W1]

**Modell
BB24**

Beim Öffnen Produkt nicht mit scharfem Messer beschädigen! Schrauben-Montage: Schraubenzieher Größe 2 (Pozidrive) verwenden. Keinen Akkuschrauber nutzen. Schienen-Demontage: Schraubenzieher, flach, Größe 2 verwenden. Ausschließ-

lich die mitgelieferten Originalschrauben verwenden!

Montage- und Bedienungsanleitung PB - D

Anlagenbreite	Anzahl der Bauteile				
					
0 - 128 cm	4	4	4	8	4

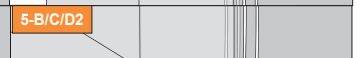
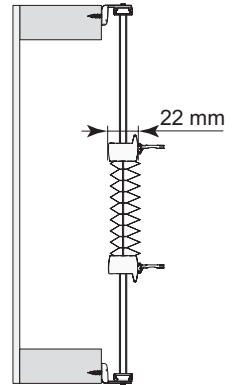
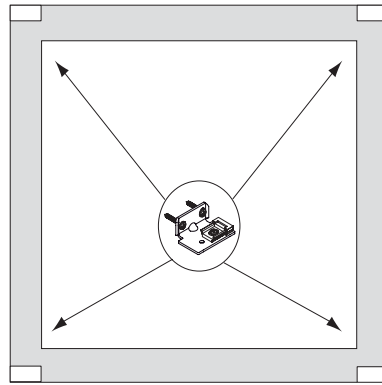
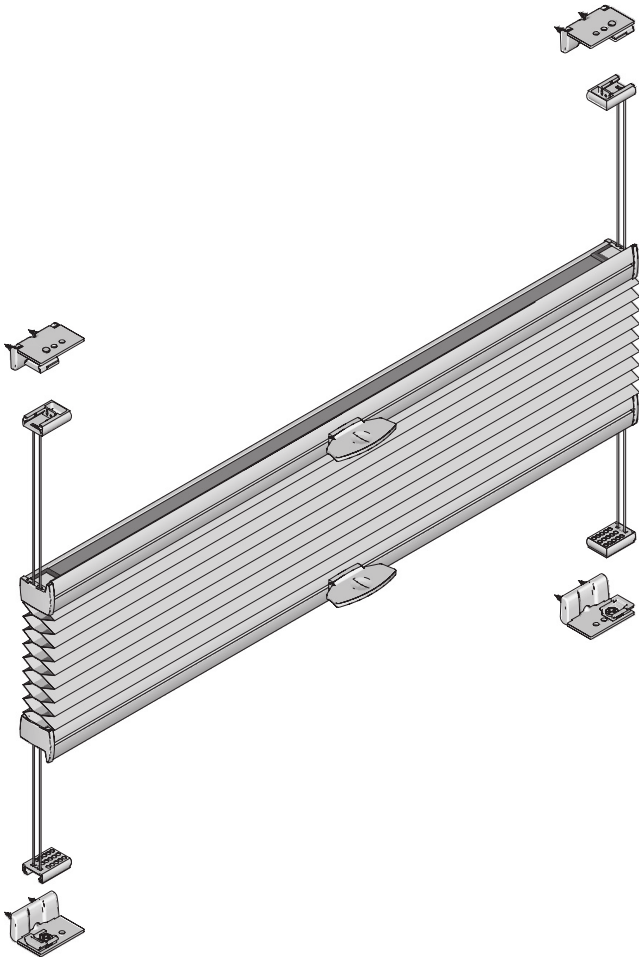

20-05-2021